

The Grand Hall

The Grand Hall hosts an array of unique spaces, including two ballrooms and a wrap-around terrace. With a breathtaking landscape of rolling hills, vines, and lakes, your guests will be mesmerized by the unparalleled panorama.

Your venue contract includes exclusive use of:

- The Grand Cru and Sparkling Ballrooms from 12pm until 11pm
- The Reserve Room with working fireplace for your cocktail hour and reception starting at 5:30pm
- Beautiful bridal suite with a private restroom
- Luxury groom's suite with HDTV
- 20 six-foot round tables
- 10 eight-foot banquet tables
- 200 Chiavari ceremony chairs
- 200 folding reception chairs
- 4 decorative wine barrels
- All existing patio furniture
- All equipment in our dedicated catering kitchen
- The Chapel for a two-hour block (subject to availability)

RATES

Peak season: \$7,500-\$11,500; May-June, September-November

Off-season: \$6,500-\$8,500; December-April, July-August

[View Grand Hall Floor Plans](#)

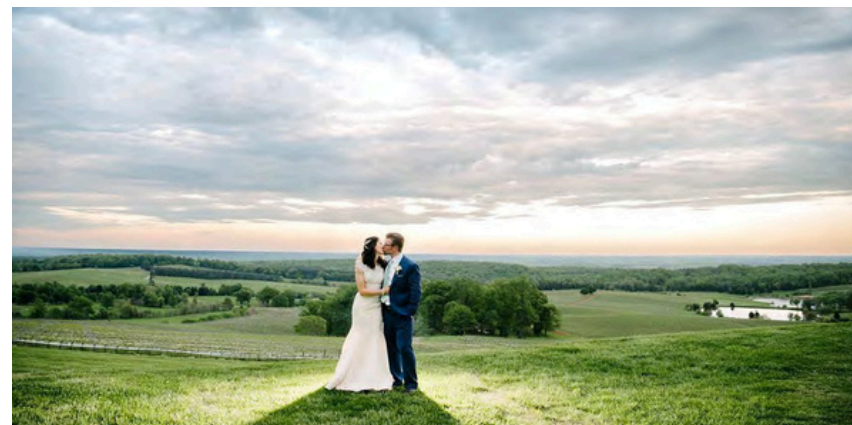

"Trump Winery is AMAZING. Our wedding ceremony and reception took place at the Grand Hall at the top of the hill. I truly believe it has the best views in all of Charlottesville." -WeddingWire



The Grand Hall

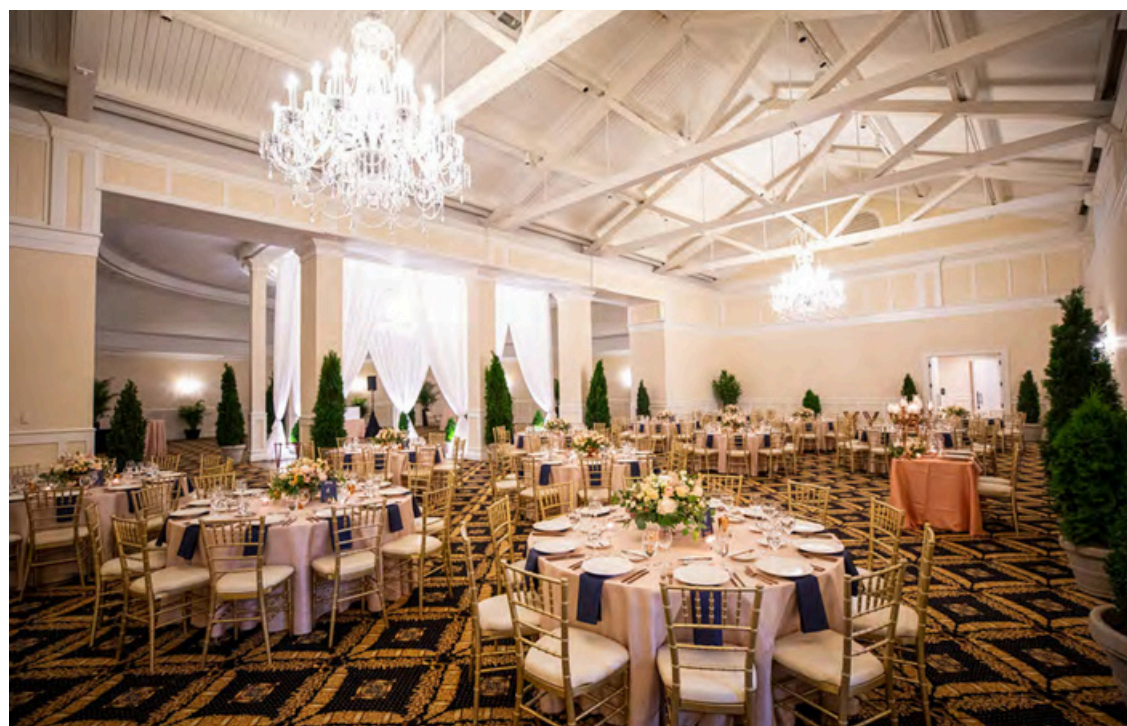
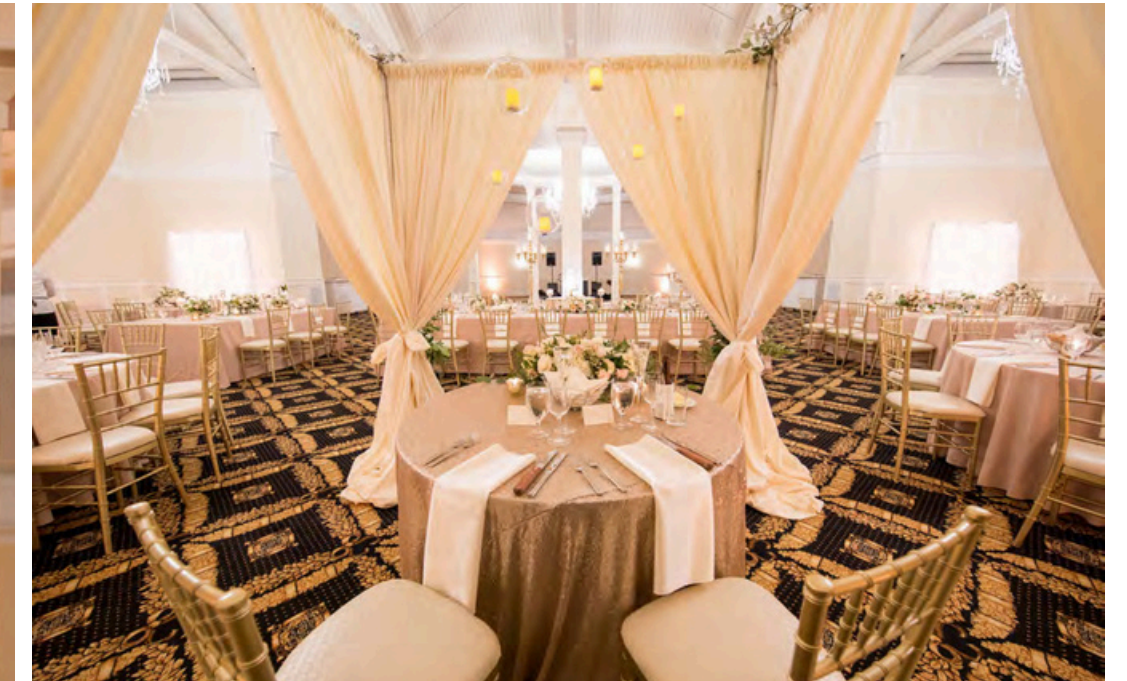

Grand Cru Ballroom

Forty-foot ceilings | Swarovski crystal chandeliers and sconces | Dance floor

The Grand Hall

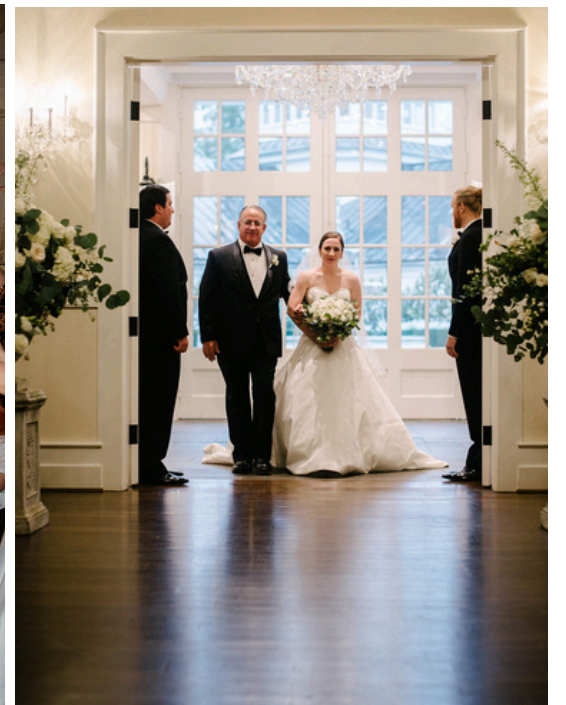

Sparkling & Grand Cru Ballrooms
Forty-foot ceilings | Swarovski crystal chandeliers and sconces

The Grand Hall



Reserve Room & Terrace

Panoramic Views | Large stone wood burning fireplace | Tufted leather furniture | Expansive windows | Marble top bar

Floor Plans - The Grand Hall

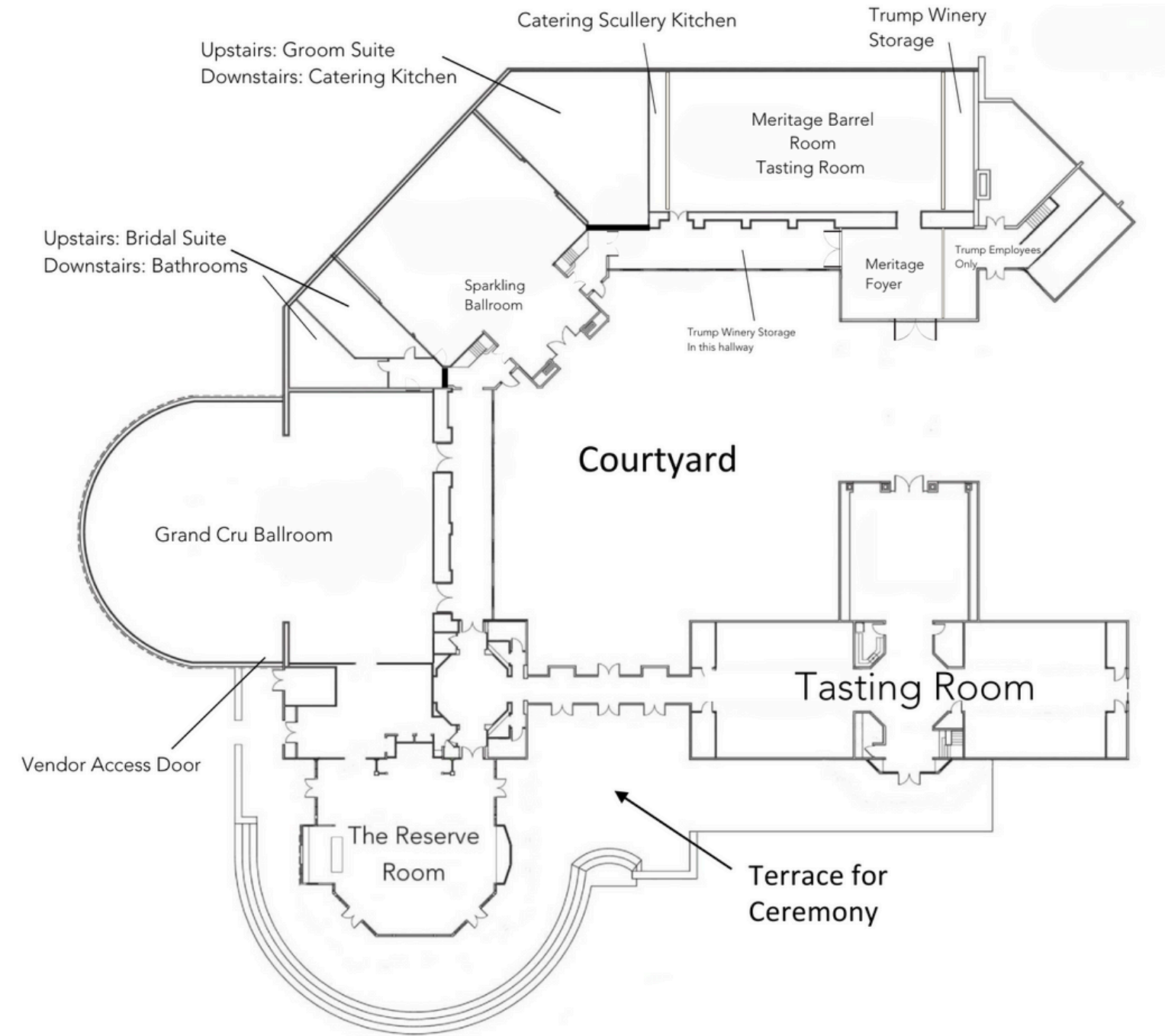

26,000 sq ft | Dressing suites | Dedicated catering kitchen | Marble restrooms

Floor Plans - The Grand Hall

GRAND CRU BALLROOM

Up to 200 seated dinner with dancing

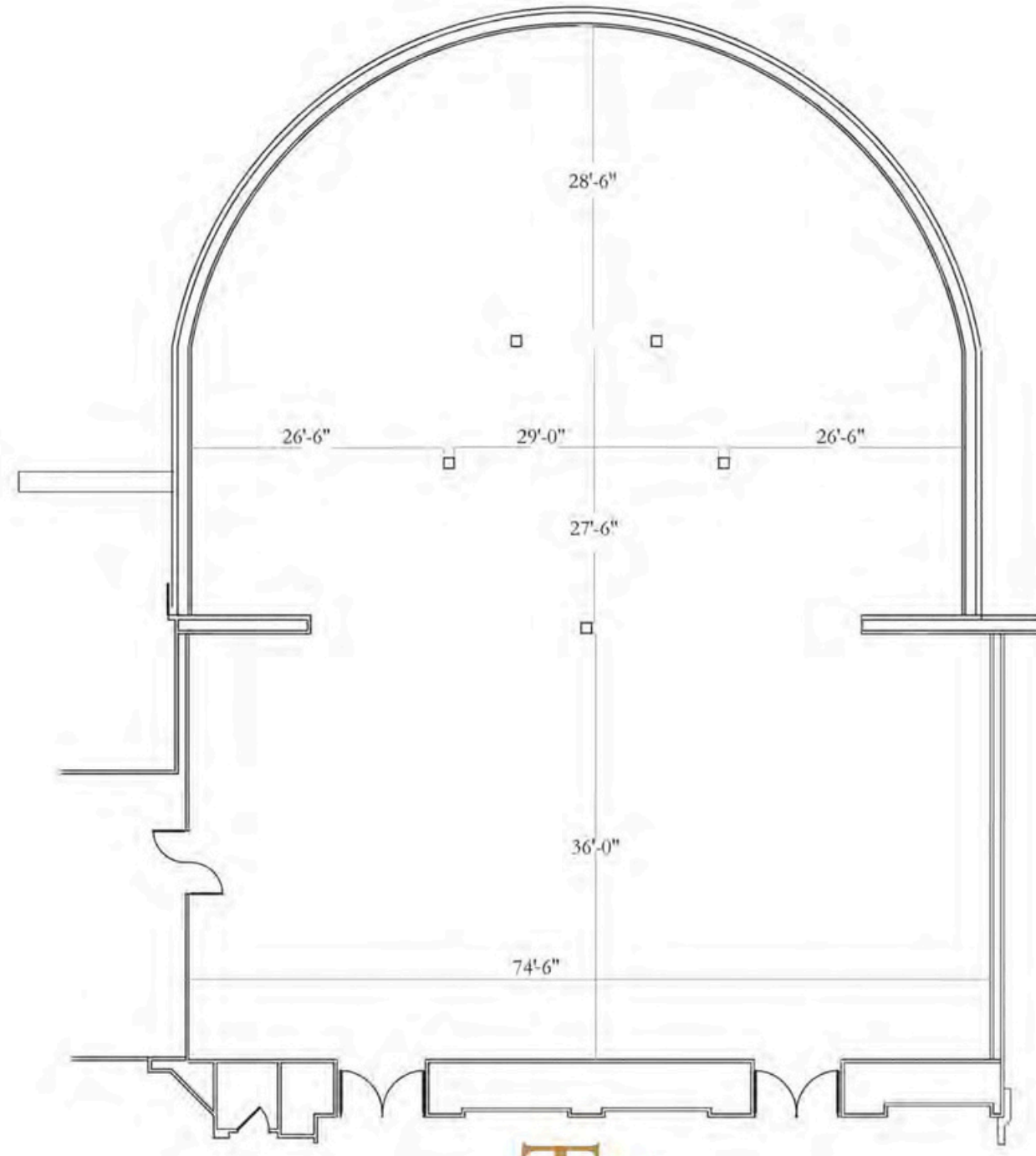

SPARKLING BALLROOM

Up to 100 seated dinner with dancing; 130 seated dinner only

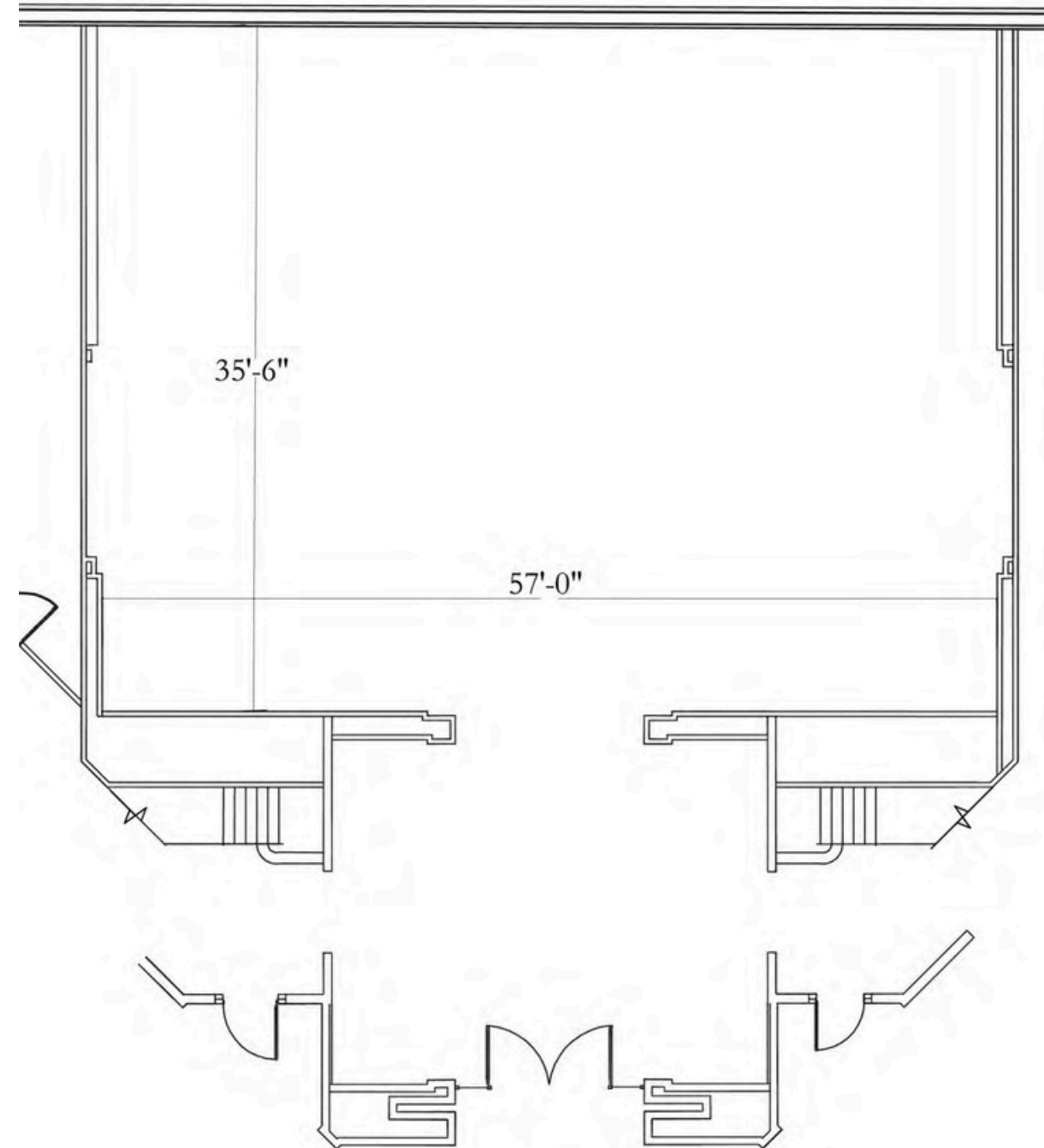

Floor Plans - The Grand Hall

RESERVE ROOM
Up to 200 cocktails

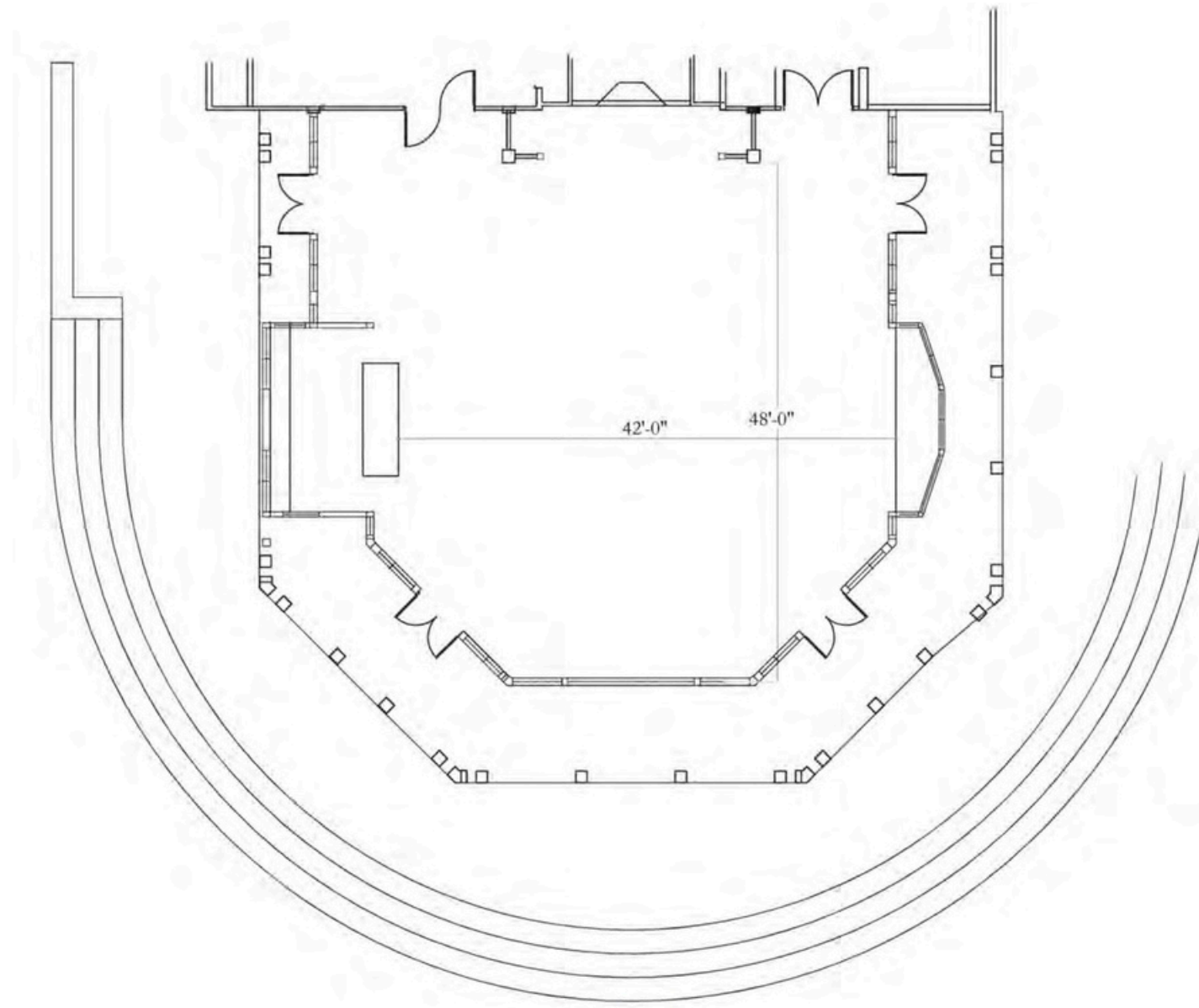

OUTDOOR TERRACE
Up to 200 ceremony chairs

